

## Size 16B HPR, Sleeve housing

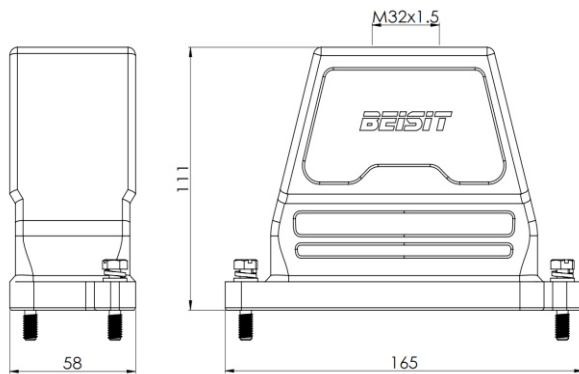

Typecode HPR16B-TO-2B-M32

ID 1 007 11 000062

### Technical Data

#### Product Properties

Series	Size 16B
Mating with	HE-016, HEE-032, HDD-072, HEEE-040, HD-040, HK-004/0, HSB-6
Housing type	Sleeve housing
Cable outlets direction	Top entry
Cable outlets	M32 x 1.5
Locking type	Screw
Protection Class	IP68
Impact strength	IK08
Temperature range	-40 °C ... 125 °C
Standard	DIN EN 175301-801

#### Insert

Housing material	Die-casting aluminum alloy
Color	Black (RAL 9005)

#### Commercial data

Weight	618 g
Packaging unit	1 pc
Country of origin	CN

### Features

- Die-casting aluminum alloy
- Top entry
- Resistant to salt spray
- Approval: UL94-V0
- RoHS-compliant

\*The design data are listed here, and the changes to the product are not described here. For unfinished matters, please contact customer service. It is the user's responsibility to verify functionality, compliance with applicable laws and instructions, and electrical safety in specific applications.