

Size 24B HPR, Surface mounted housing

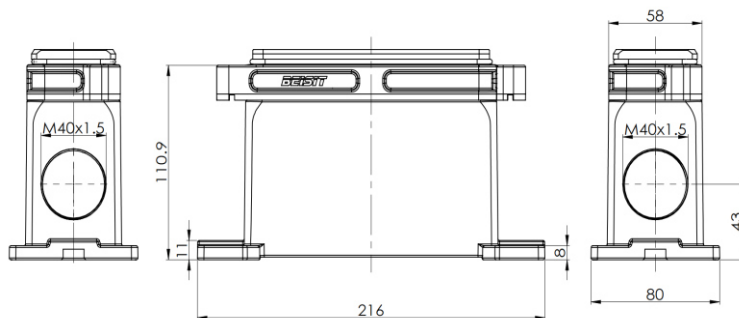

Typecode HPR24B-SM-2B-2M40

ID 1 007 11 0000125

Technical Data

Product Properties

Series	Size 24B
Mating with	HE-024, HEE-046, HDD-064, HDD-108, HK-004/8
Housing type	Surface mounted housing
Cable outlets direction	Side entry
Cable outlets	M40 x 1.5, 2
Locking type	Screw
Installation mode	Surface fixed installation
Protection Class	IP68
Impact strength	IK08
Temperature range	-40 °C ... 125 °C
Standard	DIN EN 175301-801

Insert

Housing material	Die-casting aluminum alloy
Color	Black (RAL 9005)

Commercial data

Weight	1270 g
Packaging unit	1 pc
Country of origin	CN

Features

- Die-casting aluminum alloy
- Side entry
- Surface fixed installation
- Resistant to salt spray
- Approval: UL94-V0
- RoHS-compliant

Installation Size

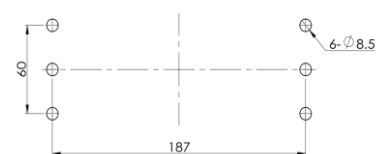

*The design data are listed here, and the changes to the product are not described here. For unfinished matters, please contact customer service. It is the user's responsibility to verify functionality, compliance with applicable laws and instructions, and electrical safety in specific applications.