

Size 16B HPR, Sleeve housing

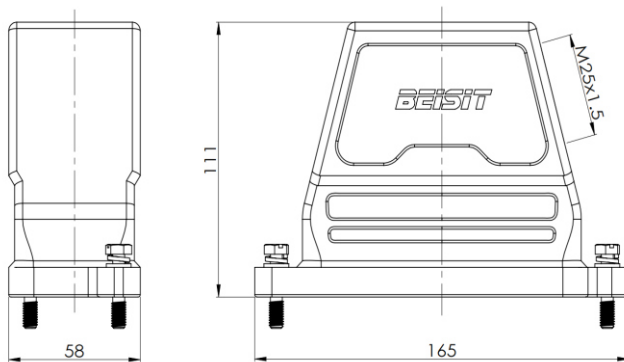

Typecode HPR16B-SO-2B-M25

ID 1 007 11 000070

Technical Data

Product Properties

Series	Size 16B
Mating with	HE-016, HEE-032, HDD-072, HEEE-040, HD-040, HK-004/0, HSB-6
Housing type	Sleeve housing
Cable outlets direction	Side entry
Cable outlets	M25 x 1.5
Locking type	Screw
Protection Class	IP68
Impact strength	IK08
Temperature range	-40 °C ... 125 °C
Standard	DIN EN 175301-801

Insert

Housing material	Die-casting aluminum alloy
Color	Black (RAL 9005)

Commercial data

Weight	617 g
Packaging unit	1 pc
Country of origin	CN

Features

- Die-casting aluminum alloy
- Side entry
- Resistant to salt spray
- Approval: UL94-V0
- RoHS-compliant

*The design data are listed here, and the changes to the product are not described here. For unfinished matters, please contact customer service. It is the user's responsibility to verify functionality, compliance with applicable laws and instructions, and electrical safety in specific applications.