

Size 24B Sleeve housing, high type, cable to cable, Stainless steel with double locking latch

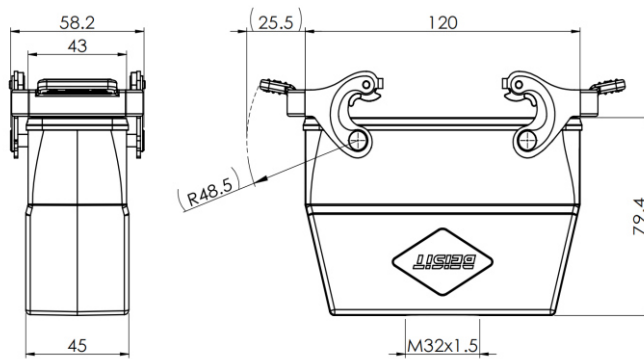

Typecode H24B-CTCH-2LS-M32
ID 1 007 01 0000736

Technical Data

Product Properties

Series	Size 24B
Mating with	HE-024, HEE-046, HDD-064, HDD-108, HK-004/8
Housing type	Sleeve housing, high type
Cable outlets direction	Lateral opening hole
Cable outlets	M32 x 1.5
Locking type	Double locking lever
Protection Class	IP67
Impact strength	IK08
Temperature range	-40 °C ... 125 °C
Standard	DIN EN 175301-801

Insert

Housing material	Die-cast aluminum
Color	Gray (RAL 7037)
Latch	Stainless steel
Seal	NBR, black

Commercial data

Weight	368 g
Packaging unit	1 pc
Country of origin	CN

Features

- Die casting of aluminum
- Stainless steel locking latch
- Lateral opening hole
- Resistant to salt spray
- Approval: UL94-V0
- RoHS-compliant

*The design data are listed here, and the changes to the product are not described here. For unfinished matters, please contact customer service. It is the user's responsibility to verify functionality, compliance with applicable laws and instructions, and electrical safety in specific applications.