

Size 24B Surface mounted hous, High type

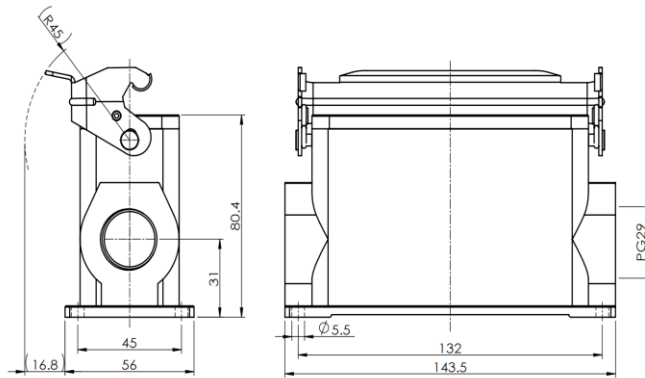

Typecode H24B-SMH-1L-PG29
ID 1 007 01 0001128

Technical Data

Product Properties

Series	Size 24B
Mating with	HE-024, HEE-046, HD-064 HDD-108, HK-004/8
Housing type	Surface mounted hous, high type
Cable outlets direction	Single-side opening
Cable outlets	PG29
Locking type	Single locking lever
Installation mode	Panel mount
Protection Class	IP65
Impact strength	IK08
Temperature range	-40 °C ... 125 °C
Standard	DIN EN 175301-801

Insert

Housing material	Die-cast aluminum
Color	Gray (RAL 7037)
Latch	Metal, surface galvanizing
Seal	NBR, black

Commercial data

Weight	470 g
Packaging unit	1 pc
Country of origin	CN

Features

- Die casting of aluminum
- All metal buckle
- Single-side opening
- Surface fixed installation
- NBR, black
- Resistant to salt spray
- Approval: UL94-V0
- RoHS-compliant

*The design data are listed here, and the changes to the product are not described here. For unfinished matters, please contact customer service. It is the user's responsibility to verify functionality, compliance with applicable laws and instructions, and electrical safety in specific applications.