

Size 6B Surface mounted hous, with thermo-plastic cover

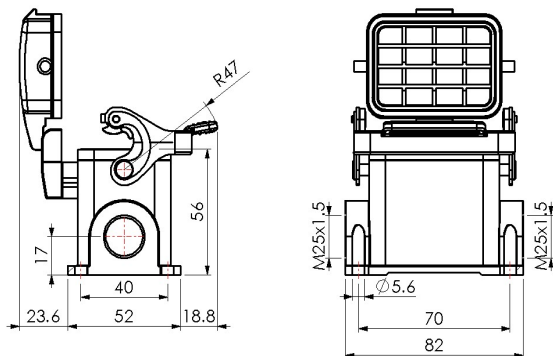

Typecode H6B-SM-1LS-PC-2M25

ID 1 007 01 0000953

Technical Data

Product Properties

Series	Size 6B
Mating with	HE-006, HEE-010, HDD-024
Housing type	Surface mounted hous
Cable outlets direction	Side entry
Cable outlets	M25 x 1.5, 2
Locking type	Single locking lever
Cover	Yes, Thermo-plastic
Installation mode	Panel mount
Protection Class	IP65
Impact strength	IK08
Temperature range	-40 °C ... 125 °C
Standard	DIN EN 175301-801

Insert

Housing material	Die-cast aluminum
Color	Gray (RAL 7037)
Latch	Stainless steel
Cover	Polycarbonate, gray
Seal	NBR, black

Commercial data

Weight	0.235 kg
Packaging unit	1 pc
Country of origin	CN

Features

- Die casting of aluminum
- Stainless steel locking latch
- Stamping resistance thermo-plastic cover
- Side entry
- Surface fixed installation
- NBR, black
- Resistant to salt spray
- Approval: UL94-V0
- RoHS-compliant

*The design data are listed here, and the changes to the product are not described here. For unfinished matters, please contact customer service. It is the user's responsibility to verify functionality, compliance with applicable laws and instructions, and electrical safety in specific applications.