

Size 16A Relay housing

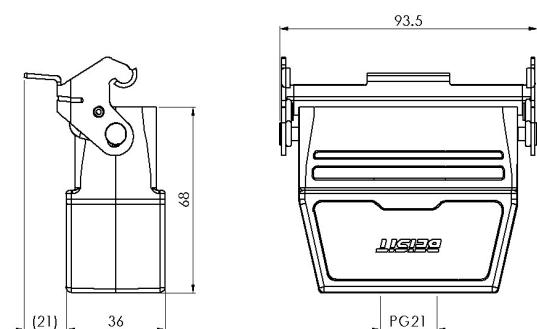

Typecode H16A-CTC-1L-PG21

ID 1 007 01 000088

Technical Data

Product Properties

Series	Size 16A
Mating with	HA-016, HD-025
Housing type	Relay housing
Cable outlets direction	Top opening hole
Cable outlets	PG21
Locking type	Single locking lever
Protection Class	IP65
Impact strength	IK08
Temperature range	-40 °C ... 125 °C
Standard	DIN EN 175301-801

Insert

Housing material	Die-cast aluminium
Color	Gray (RAL 7037)
Latch	Metal, surface galvanizing

Commercial data

Weight	0.150 kg
Packaging unit	1 pc
Country of origin	CN

Features

- Die casting of aluminium
- All metal buckle
- Top opening hole
- Resistant to salt spray
- Approval: UL94-V0
- RoHS-compliant

*The design data are listed here, and the changes to the product are not described here. For unfinished matters, please contact customer service. It is the user's responsibility to verify functionality, compliance with applicable laws and instructions, and electrical safety in specific applications.