

Size 10A Surface mounted hous, with thermo-plastic cover

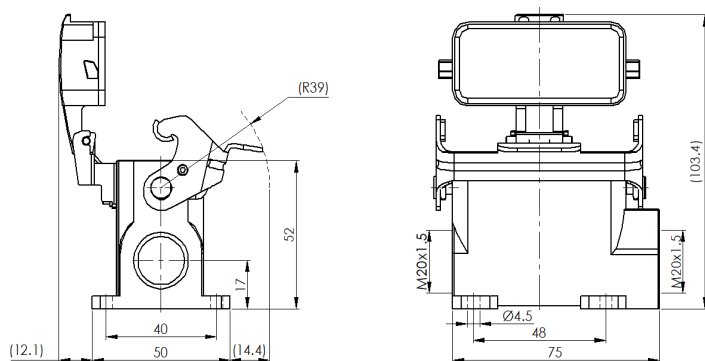

Typecode H10A-SM-1L-PCG-2M20

ID 1 007 01 000050

Technical Data

Product Properties

Series	Size 10A
Mating with	HA-010, HD-015
Housing type	Surface mounted hous
Cable outlets direction	Side entry
Cable outlets	M20 x 1.5, 2
Locking type	Single locking lever
Cover	Yes, Thermo-plastic
Installation mode	Panel mount
Protection Class	IP65
Impact strength	IK08
Temperature range	-40 °C ... 125 °C
Standard	DIN EN 175301-801

Insert

Housing material	Die-cast aluminum
Color	Gray (RAL 7037)
Latch	Metal, surface galvanizing
Cover	Polycarbonate, gray
Seal	NBR, black

Commercial data

Weight	0.174 kg
Packaging unit	1 pc
Country of origin	CN

Features

- Die casting of aluminum
- All metal buckle
- Stamping resistance thermo-plastic cover
- Side entry
- Surface fixed installation
- NBR, black
- Resistant to salt spray
- Approval: UL94-V0
- RoHS-compliant

*这里所列的是设计数据，有关产品的变更不在此做说明，未尽事宜请联系客服。用户有责任验证功能、符合适用的法律和指令以及在特定应用中的电气安全。