

Size 16A Sleeve housing, Lateral opening hole

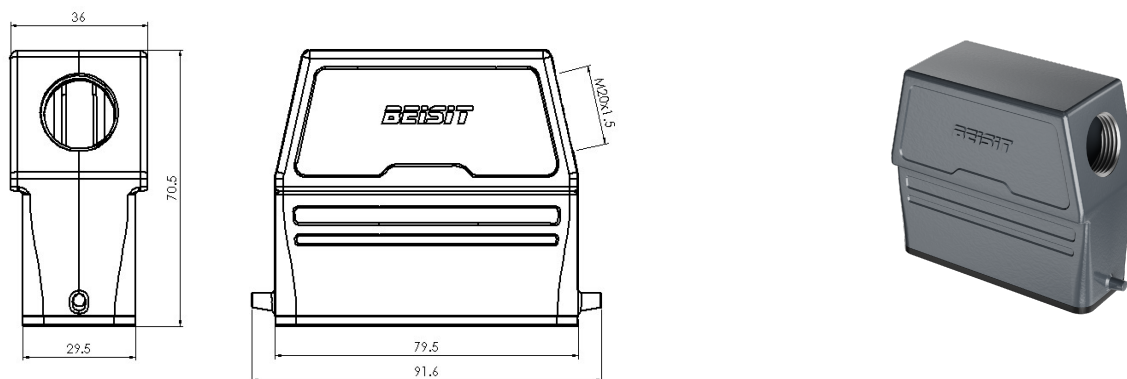

Typecode H16A-SO-2P-M20

ID 1 007 01 0000059

Technical Data

Product Properties

Series	Size 16A
Mating with	HA-016, HD-025
Housing type	Sleeve housing
Cable outlets direction	Lateral opening hole
Cable outlets	M20 x 1.5
Protection Class	IP65
Impact strength	IK08
Temperature range	-40 °C ... 125 °C
Standard	DIN EN 175301-801

Insert

Housing material	Die-cast aluminum
Color	Gray (RAL 7037)
Seal	NBR, black

Commercial data

Weight	0.156 kg
Packaging unit	1 pc
Country of origin	CN

Features

- Die casting of aluminum
- Lateral opening hole
- NBR, black
- Resistant to salt spray
- Approval: UL94-V0
- RoHS-compliant

*这里所列的是设计数据，有关产品的变更不在此做说明，未尽事宜请联系客服。用户有责任验证功能、符合适用的法律和指令以及在特定应用中的电气安全。