

Size 10A Sleeve housing, Top opening hole

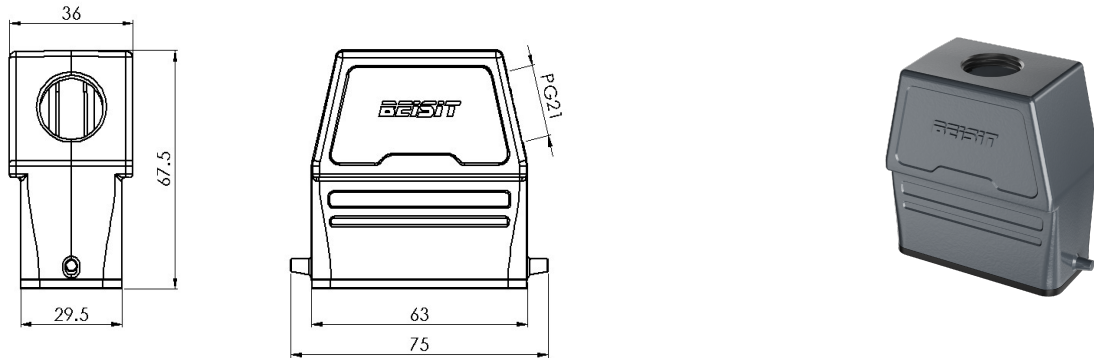

Typecode H10A-TO-2P-PG21

ID 1 007 01 0000038

Technical Data

Product Properties

Series	Size 10A
Mating with	HA-010, HD-015
Housing type	Sleeve housing
Cable outlets direction	Top opening hole
Cable outlets	PG21
Protection Class	IP65
Impact strength	IK08
Temperature range	-40 °C ... 125 °C
Standard	DIN EN 175301-801

Insert

Housing material	Die-cast aluminum
Color	Gray (RAL 7037)
Seal	NBR, black

Commercial data

Weight	0.127 kg
Packaging unit	1 pc
Country of origin	CN

Features

- Die casting of aluminum
- Top opening hole
- NBR, black
- Resistant to salt spray
- Approval: UL94-V0
- RoHS-compliant

*这里所列的是设计数据，有关产品的变更不在此做说明，未尽事宜请联系客服。用户有责任验证功能、符合适用的法律和指令以及在特定应用中的电气安全。